



CONTROLLER N1040

USER GUIDE V2.2x C



NOVUS
We Measure, We Control, We Record



1.	SAFETY ALERTS.....	3
2.	INSTALLATION / CONNECTIONS	4
2.1	ELECTRICAL CONNECTIONS	4
2.2	INSTALLATION RECOMMENDATIONS.....	4
3.	FEATURES.....	5
3.1	INPUT TYPE SELECTION	5
3.2	OUTPUTS.....	5
3.3	CONTROL OUTPUT.....	5
3.4	ANALOG OUTPUT OR CURRENT OUTPUT	5
3.5	ALARM OUTPUT	6
3.6	INITIAL BLOCKING OF ALARM.....	6
3.7	SAFE OUTPUT VALUE WITH SENSOR FAILURE	6
3.8	LBD FUNCTION – LOOP BREAK DETECTION	6
3.9	OFFSET	7
3.10	USB INTERFACE	7
4.	OPERATION.....	8
4.1	STARTUP	8
5.	PARAMETER DESCRIPTION.....	9
5.1	OPERATION CYCLE.....	9
5.2	TUNING CYCLE	9
5.3	ALARMS CYCLE	10
5.4	INPUT CYCLE	10
5.5	CALIBRATION CYCLE	11
6.	CONFIGURATION PROTECTION.....	12
6.1	ACCESS PASSWORD	12
6.2	PROTECTION ACCESS PASSWORD	12
6.3	MASTER PASSWORD.....	12
7.	DEFINITION OF PID PARAMETERS	13
8.	MAINTENANCE.....	14
8.1	PROBLEMS WITH THE CONTROLLER.....	14
8.2	INPUT CALIBRATION	14
8.3	ANALOG OUTPUT CALIBRATION	14
9.	SERIAL COMMUNICATION.....	15
9.1	FEATURES.....	15
9.2	PARAMETER CONFIGURATION	15
9.3	COMMUNICATION PROTOCOL.....	15
9.4	HOLDING REGISTERS TABLE	15
10.	IDENTIFICATION	17
11.	SPECIFICATIONS.....	18
12.	WARRANTY	19

1. SAFETY ALERTS

The symbols below are used on the equipment and throughout this document to draw the user's attention to important operational and safety information.

	
CAUTION: Read the manual thoroughly before installing and operating the equipment.	CAUTION OR DANGER: Electrical shock hazard.

All safety related instructions that appear in the manual must be observed to ensure personal safety and to prevent damage to either the instrument or the system. If the instrument is used in a manner not specified by the manufacturer, the protection provided by the equipment may be impaired.

2. INSTALLATION / CONNECTIONS

The controller must be fastened on a panel, following the sequence of steps described below:

- Prepare a panel cut-out according to [SPECIFICATIONS](#).
- Remove the mounting clamps from the controller.
- Insert the controller into the panel cut-out.
- Slide the mounting clamp from the rear to a firm grip at the panel.

2.1 ELECTRICAL CONNECTIONS

Figure 1 below shows the electrical terminals of the controller:

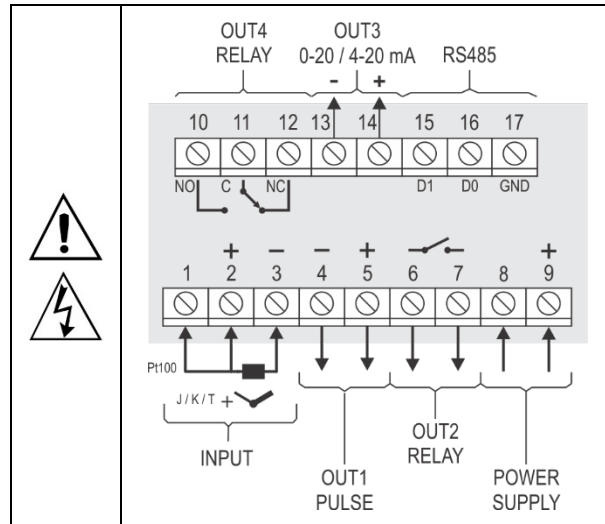

Figure 1 – Electrical connections

2.2 INSTALLATION RECOMMENDATIONS

- All electrical connections are made to the screw terminals at the rear of the controller.
- To minimize the pick-up of electrical noise, the low voltage DC connections and the sensor input wiring should be routed away from high-current power conductors. If this is impractical, use shielded cables. In general, keep cable lengths to a minimum.
- All electronic instruments must be powered by a clean mains supply, proper for instrumentation.
- It is strongly recommended to apply RC'S FILTERS (noise suppressor) to contactor coils, solenoids, etc. In any application it is essential to consider what can happen when any part of the system fails. The controller features by themselves cannot assure total protection.

3. FEATURES

3.1 INPUT TYPE SELECTION

Table 1 shows the sensor types accepted and their respective codes and ranges:

TYPE	CODE	MEASUREMENT RANGE
Thermocouple J	tc J	Range: -110 to 950 °C (-166 to 1742 °F)
Thermocouple K	tc K	Range: -150 to 1370 °C (-238 to 2498 °F)
Thermocouple T	tc T	Range: -160 to 400 °C (-256 to 752 °F)
Pt100	Pt	Range: -200 to 850 °C (-328 to 1562 °F)

Table 1 – Input types

3.2 OUTPUTS

The controller offers two, three or four output channels, depending on the loaded optional features. The output channels are user configurable as **Control Output**, **Alarm 1 Output**, **Alarm 2 Output**, **Alarm 1 OR Alarm 2 Output**, and **LBD (Loop Break Detect) Output**.

OUTPUT OUT1	Pulse type output of electrical voltage. 5 Vdc / 50 mA max. Available on terminals 4 and 5.
OUTPUT OUT2	SPST-NO relay. Available on terminals 6 and 7.
OUTPUT OUT3	SPST-NO relay. Available on terminals 13 and 14 (PRRR Model). Analog Output or Current Output. 0-20 / 4-20 mA, 500 R max. Available on terminals 13 and 14 (PRAR model).
OUTPUT OUT4	SPDT relay. Available on terminals 10, 11, and 12.

3.3 CONTROL OUTPUT

It is the output that will command the process actuator (heating resistor, cooling compressor, etc.). The control output can be directed to a relay, an analog output, or even a Pulse type Electrical Voltage output, according to availability.

3.4 ANALOG OUTPUT OR CURRENT OUTPUT

The controller has an analog output of electric current that can perform the following functions:

- Process control output
- Process PV retransmission output
- Process SP retransmission output

As a control output, it relates the MV range (0 to 100 %) to the current range: 4 to 20 mA or 0 to 20 mA.

- 0 % MV determines 4 mA (or 0 mA) on the Analog Output
- 100 % MV determines 20 mA on the Analog Output

As the PV / SP relay output of the process, the electrical current applied to the analog output will be proportional to the ratio between the value of the variable (PV or SP) and the retransmission range defined by parameters **rELL** and **rEHL**.

The analog output is electrically isolated from the other controller circuits.

It has a measurement accuracy of 0.25 % of the Operating Range or 0.4 mA.

3.5 ALARM OUTPUT

The controller contains 2 alarms that can be directed (assigned) to any output channel. The alarm functions are described in **Table 2**:



oFF	Output is not used as alarm.	
Lo	Alarm of absolute minimum value. Triggers when the value of measured PV is below the value defined for alarm Setpoint (SPA1 or SPA2).	
HI	Alarm of absolute maximum value. Triggers when the value of measured PV is above the value defined for alarm Setpoint.	
dIF	Alarm of differential value. In this function the parameters SPA1 and SPA2 represent the deviation of PV in relation to the SP of CONTROL.	
	 Positive SPA1	 Negative SPA1
dIFL	Alarm of minimum differential value. It triggers when the value of PV is below the defined point by (using the Alarm 1 as example).	
	 Positive SPA1	 Negative SPA1
dIFH	Alarm of valor maximum differential value. Triggers when the value of PV is above the defined point by (using Alarm 1 as example):	
	 Positive SPA1	 Negative SPA1
iErr	Alarms of the Sensor Break (Sensor Break Alarm). It is activated when the Input presents problems such as interrupted sensor, bad connection, etc.	

Table 2 – Alarm functions

Note: Alarm functions on **Table 2** are also valid for Alarm 2 (SPA2).

Important note: Alarms configured with the **HI**, **dIF**, and **dIFH** functions also trigger their associated output when a sensor fault is identified and signaled by the controller. A relay output, for example, configured to act as a High Alarm (**HI**), will operate when the SPAL value is exceeded and when the sensor connected to the controller input is broken.

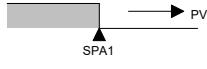
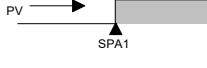
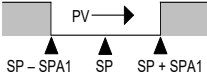
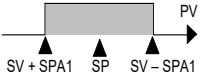
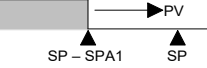
3.6 INITIAL BLOCKING OF ALARM

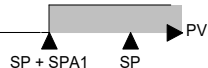
The **Initial Blocking** option inhibits the alarm from being recognized if an alarm condition is present when the controller is first energized. The alarm will be enabled only after the occurrence of a non-alarm condition.

The initial blocking is useful, for example, when one of the alarms is configured as a minimum value alarm, causing the activation of the alarm soon upon the process start-up, an occurrence that may be undesirable.

The initial blocking is disabled for the sensor break alarm function **iErr** (Open sensor).

3.7 SAFE OUTPUT VALUE WITH SENSOR FAILURE

Function that places the control output in a safe condition for the process when is identified an error in the sensor input.

With a fault identified in the sensor, the controller determines the percentage value defined in parameter **iEou** for the control output. The controller will remain in this condition until the sensor failure disappears. **iEou** values are only 0 and 100 % when in ON/OFF control mode. For PID control mode, any value in the range from 0 to 100 % is accepted.

3.8 LBD FUNCTION – LOOP BREAK DETECTION

The **LbdL** parameter allows you to set a maximum time interval (in minutes) for the process temperature (PV) to react to the command from the control output. If the PV does not react properly within the time interval configured, the controller signals in its display the occurrence of the **LBD** event, which indicates problems in the control loop.

The **LBD** event can also be sent to one of the output channels of the controller. To do this, simply configure the desired output channel with the **Ldb** function which, in the event of this event, is triggered.

This function is disabled with value 0 (zero).

This function allows the user to detect problems in the installation, such as defective actuators, power supply failure, etc.

3.9 OFFSET

Feature that allows the user to make small adjustment in the temperature indication. Allows correcting measurement differences that appear, for example, when replacing the temperature sensor.

3.10 USB INTERFACE

The USB interface is used to CONFIGURE, MONITOR, or UPDATE the controller FIRMWARE. The user should use **QuickTune** software, which offers features to create, view, save and open settings from the device or files on the computer. The tool for saving and opening configurations in files allows the user to transfer settings between devices and perform backup copies.

For specific models, **QuickTune** allows to update the firmware (internal software) of the controller via the USB interface.

For MONITORING purposes, the user can use any supervisory software (SCADA) or laboratory software that supports the MODBUS RTU communication over a serial communication port. When connected to a computer's USB, the controller is recognized as a conventional serial port (COM x).

The user must use **QuickTune** software or consult the DEVICE MANAGER on the Windows Control Panel to identify the COM port assigned to the controller.

The user should consult the mapping of the MODBUS memory in the controller's communication manual and the documentation of the supervision software to start the MONITORING process.

Follow the procedure below to use the USB communication of the device:

1. Download **QuickTune** software from our website and install it on the computer. The USB drivers necessary for operating the communication will be installed with the software.
2. Connect the USB cable between the device and the computer. The controller does not have to be connected to a power supply. The USB will provide enough power to operate the communication (other device functions may not operate).
3. Run the **QuickTune** software, configure the communication and start the device recognition.



The USB interface IS NOT SEPARATE from the signal input (PV) or the controller's digital inputs and outputs. It is intended for temporary use during CONFIGURATION and MONITORING periods.

For the safety of people and equipment, it must only be used when the piece of equipment is completely disconnected from the input/output signals.

Using the USB in any other type of connection is possible but requires a careful analysis by the person responsible for installing it.

When MONITORING for prolonged periods of time and with connected inputs and outputs, we recommend using the RS485 interface.

4. OPERATION

The front panel can be seen in **Figure 2**:

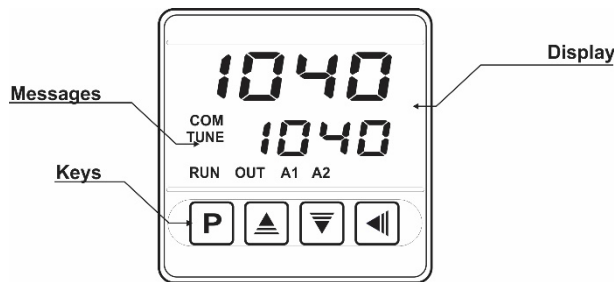

Figure 2 – Identification of the parts referring to the front panel

Display: Displays the measured variable, symbols of the configuration parameters and their respective values/conditions.

COM Indicator: Flashes to indicate communication activity in the RS485 interface.

TUNE Indicator: Stays ON while the controller is in tuning process.

OUT Indicator: For relay or pulse control output; it reflects the actual state of the output.

A1 and A2 Indicators: Signalize the occurrence of alarm situation.

P Key: Used to walk through the menu parameters.

▲ Increment key and ▼ Decrement key: Allow altering the values of the parameters.

◀ Back key: Used to retrocede parameters.

4.1 STARTUP

When the controller is powered up, it displays its firmware version for 3 seconds, after which the controller starts normal operation. The value of PV and SP is then displayed, and the outputs are enabled.

For the controller to operate properly in a process, its parameters need to be configured first, such that it can perform accordingly to the system requirements. The user must be aware of the importance of each parameter and for each one determines a valid condition.

The parameters are grouped in cycles, according to their functionality and operation easiness. The 5 cycles of parameters are:

1 – Operation / 2 – Tuning / 3 – Alarms / 4 – Input / 5 – Calibration

The **P** key is used for accessing the parameters within a cycle.

Keeping the **P** key pressed, at every 2 seconds the controller jumps to the next cycle of parameters, showing the first parameter of each cycle:

PV >> RUN >> FURI >> TYPE >> PASS >> PV ...

To enter a particular cycle, simply release the **P** key when the first parameter in that cycle is displayed. To walk through the parameters in a cycle, press the **P** key with short strokes. To go back to the previous parameter in a cycle, press **◀**.

Each parameter is displayed with its prompt in the upper display and value/condition in the lower display. Depending on the level of parameter protection adopted, the parameter **PASS** precedes the first parameter in the cycle where the protection becomes active. See section [CONFIGURATION PROTECTION](#).

5. PARAMETER DESCRIPTION

5.1 OPERATION CYCLE

PV + SP	PV Indication screen. On the higher display (red) the value of the measured variable (PV) temperature is shown. On the lower display (green), the control Setpoint (SP) is shown.
SPR1 SPR2 Setpoint Alarm	Alarm SP. Value that defines the alarm activation point. For the alarms set up with the Differential functions, these parameters define deviations. This parameter is not used for the alarm function IErr . Parameters shown in this cycle only when enabled in the parameters SP1E and SP2E .

5.2 TUNING CYCLE

Autun Auto-tuning	AUTO-TUNE. Enables the auto-tuning function for the PID parameters (Pb , Ir , dt). Defines the control strategy to be taken: oFF Turned off (no PID tuning). FRSt Automatic tuning. FULL More accurate automatic tuning.
Pb Proportional Band	Proportional Band. Value of the term P of the control mode PID, in percentage of the maximum span of the input type. Adjust of between 0 and 500.0 %. When set to zero (0), control action is ON/OFF.
Ir Integral Rate	Integral Rate. Value of the term I of the PID algorithm, in repetitions per minute (Reset). Adjustable between 0 and 24.00. Displayed only if proportional band \neq 0.
dt Derivative Time	Derivative Time. Value of the term D of the control mode PID, in seconds. Adjustable between 0 and 250.0 seconds. Displayed only if proportional band \neq 0.
Ct Cycle Time	Cycle time. Pulse Width Modulation (PWM) period in seconds. Adjustable between 0.5 and 100.0 seconds. Displayed only if proportional band \neq 0.
HYSL Hysteresis	Hysteresis. Is the hysteresis for ON/OFF control (set in temperature units). This parameter is only used when the controller is in ON/OFF mode (Pb=0).
Act Action	Action control: rE Control with Reverse Action . Appropriate for heating . Turns control output on when PV is below SP. dIr Control with Direct Action . Appropriate for cooling . Turns control output on when PV is above SP.
SFSt Soft Start	Soft Start Function. Time interval, in seconds, while the controller limits the control output (MV) rising rate. (Zero value disables the Soft Start function).
out1 out2 out3 out4 Output	Assign functions to the Output channels OUT1, OUT2, OUT3, and OUT4: oFF Not used. Ctrl Control output. R1 Alarm 1 output. R2 Alarm 2 output. R1R2 Alarm 1 + Alarm2 (OR logic). Lbd Loop Break Detect Alarm.
out3 Output	On controller models with the analog output feature, the OUT3 configuration options are: oFF Non-used output. c0.20 Control output 0 to 20 mA. c4.20 Control output 4 to 20 mA. P0.20 Retransmission in 0 to 20 mA of the measured temperature value (PV). P4.20 Retransmission in 4 to 20 mA of the measured temperature (PV) value. S0.20 Retransmission in 0 to 20 mA of the Setpoint value (SP). S4.20 Retransmission in 4 to 20 mA of the Setpoint value (SP).

5.3 ALARMS CYCLE

FuR1 FuR2 <i>Function Alarm</i>	Alarm functions. Defines the functions for the alarms among the options of the Table 2 .
SPR1 SPR2 <i>Setpoint Alarm</i>	Alarm SP. Value that defines the point of activation of the alarm outputs. For the alarms programmed with the Differential functions, these parameters represent the deviations. This parameter is not used for the alarm function IErr .
SP1E SP2E <i>Setpoint Enable</i>	SP Enable. Configures display of SPA1 and SPA2 also in the Operation Cycle: YES SPA1/SPA2 are displayed in the Operation Cycle. no SPA1/SPA2 are not displayed in the Operation Cycle.
bLR1 bLR2 <i>Blocking Alarm</i>	Blocking alarms. YES Enables initial blocking. no Inhibits initial blocking.
HYR1 HYR2 <i>Hysteresis Alarm</i>	Alarm hysteresis. Defines the difference between the value of PV at which the alarm is triggered and the value at which it is turned off.
FLSh <i>Flash</i>	Allows visual signalization of an alarm occurrence by flashing the indication of PV in the Operation Cycle: YES Enables alarm signaling when flashing PV. no Disables alarm signaling when flashing PV.

5.4 INPUT CYCLE

TYPE <i>Type</i>	Input Type. Selects the input signal type to be connected to the process variable input. Refer to Table 1 for the available options. (J) tc J -110 to 950 °C / -166 to 1742 °F (K) tc P -150 to 1370 °C / -238 to 2498 °F (T) tc t -160 to 400 °C / -256 to 752 °F (Pt100) Pt -200 to 850 °C / -328 to 1562 °F
FLtr <i>Filter</i>	Digital Input Filter. Used to improve the stability of the measured signal (PV). Adjustable between 0 and 20. In 0 (zero) it means filter turned off and 20 means maximum filter. The higher the filter value, the slower is the response of the measured value.
dPPO <i>Decimal Point</i>	Decimal point position. When configuring the input (TYPE) with temperature sensors (J, K, Pt100, etc), in addition to the integer part of the measurement, the dPPO parameter will only display decimal values (XXX.X). When configuring the input (TYPE) with linear signals (mA, mV, V), the dPPO parameter determines the position of the decimal point of the measured value (XXXX, XXX.X, XX.XX, X.XXX).
un t <i>Unit</i>	Selects display indication for degrees Celsius or Fahrenheit: C Indication in Celsius. F Indication in Fahrenheit.
OFFS <i>Offset</i>	Offset value to be added to the PV reading to compensate sensor error. Default value: Zero.
SPLL <i>SP Low Limit</i>	SP Low Limit. Defines the SP lower limit of.
SPHL <i>SP High Limit</i>	SP High Limit. Defines the upper limit for adjustment of SP.
re.LL <i>Retransmission Low Limit</i>	Retransmission Low Limit. Allows you to set the lower limit of the SP or PV retransmission range on OUT3. Parameter displayed only when selecting one of the Retransmit functions available for the Analog Output.
re.HL <i>Retransmission High Limit</i>	Retransmission High Limit. Allows you to set the upper limit of the SP or PV retransmission range on OUT3. Parameter displayed only when selecting one of the Retransmission functions available for the Analog Output.
LbdE <i>Loop Break Detection time</i>	Loop Break Detection Time. Time interval for the LBD function. Defines the maximum interval of time for the PV to react to a control command. In minutes.
IEou	Percentage value to be applied to the output on any failure of the sensor that is connected to the controller input.
bAud <i>Baud Rate</i>	Digital communication Baud Rate selection. In kbps with the following speeds available: 1.2, 2.4, 4.8, 9.6, 19.2, 38.4, 57.6, and 115.2. Parameter shown only on models with serial communication.

Prty Parity	Parity of the serial communication: nonE Without parity. E!En Even parity. Odd Odd parity. Parameter shown only on models with serial communication.
Rddr Address	Communication address. Number that identifies the controller in the serial communication network, between 1 and 247. Parameter shown only on models with serial communication.

5.5 CALIBRATION CYCLE

All types of input are calibrated in the factory. In case a recalibration is required; it shall be carried out by a specialized professional. In case this cycle is accidentally accessed, do not perform alteration in its parameters.

PASS Password	Password. This parameter is presented before the protected cycles. See item Protection of Configuration.
CLb Calibration	Calibration. Enables the possibility for calibration of the indicator. When the calibration is not enabled, the related parameters are hidden.
in.LC Input Low Calibration	Input Low Calibration. Enter the value corresponding to the low scale signal applied to the analog input.
in.HC Input High Calibration	Input High Calibration. Enter the value corresponding to the full-scale signal applied to the analog input.
Ro.LC Analog Output Low Calibration	Analog Output Low Calibration. Analog Output (AO) user calibration. Declaration of the electrical current value present at the analog output. Low point adjustments. See MAINTENANCE chapter.
Ro.HC Analog Output High Calibration	Analog Output High Calibration. Analog Output (AO) user calibration. Declaration of the electrical current value present at the analog output. High point adjustments. See MAINTENANCE chapter.
rStR Restore	Restore. Restores the factory calibration for all inputs and outputs, disregarding modifications carried out by the user.
CJ Cold Junction	Cold Junction. This screen is for information purpose only.
PASc Password Change	Password Change. Allows defining a new access password, always different from zero
Prot Protection	Protection. Sets up the Protection Level. See Table 3 .

6. CONFIGURATION PROTECTION

The controller provides means for protecting the parameters configurations, not allowing modifications to the parameter values, avoiding tampering or improper manipulation.

The parameter **Protection (Prot)**, in the Calibration Cycle, determines the protection strategy, limiting the access to levels, as shown in the table below:

PROTECTION LEVEL	PROTECTION CYCLES
1	Only the Calibration cycle is protected.
2	Calibration and Input cycles are protected.
3	Calibration, Input, and Alarms cycles are protected.
4	Calibration, Input, Alarms, and Tuning cycles are protected.
5	All cycles are protected, but the SP screen in the Operation Cycle.
6	All cycles are protected, including SP.

Table 3 – Levels of protection

6.1 ACCESS PASSWORD

The protected cycles, when accessed, request the user to provide the **Access Password** for granting permission to change the configuration of the parameters on these cycles.

The prompt **PASS** precedes the parameters on the protected cycles. If no password is entered, the parameters of the protected cycles can only be visualized.

The Access Password is defined by the user in the parameter **Password Change (PASC)**, present in the Calibration Cycle. **The factory default for the password code is 1111.**

6.2 PROTECTION ACCESS PASSWORD

The protection system built into the controller blocks for 10 minutes the access to protected parameters after 5 consecutive frustrated attempts of guessing the correct password.

6.3 MASTER PASSWORD

The Master Password is intended for allowing the user to define a new password in the event of it being forgotten. The Master Password does not grant access to all parameters, only to the **Password Change** parameter (**PASC**). After defining the new password, the protected parameters may be accessed (and modified) using this new password.

The master password is made up by the last three digits of the serial number of the controller **added** to the number 9000. As an example, for the equipment with serial number 07154321, the master password is 9 3 2 1.

Controller serial number is displayed by pressing  for 5 seconds.

7. DEFINITION OF PID PARAMETERS

During the process of determining automatically the PID parameters, the system is controlled in **ON/OFF** in the programmed Setpoint. The auto-tuning process may take several minutes to be completed, depending on the system. The steps for executing the PID auto-tuning are:

- Select the process Setpoint.
- Enable auto-tuning at the parameter **Auto**, selecting **FAST** or **FULL**.

The option **FAST** performs the tuning in the minimum possible time, while the option **FULL** gives priority to accuracy over the speed.

The sign TUNE remains lit during the whole tuning phase. The user must wait for the tuning to be completed before using the controller.

During auto tuning period the controller will impose oscillations to the process. PV will oscillate around the programmed set point and controller output will switch on and off many times.

If the tuning does not result in a satisfactory control, refer to **Table 4** for guidelines on how to correct the behavior of the process:

PARAMETER	VERIFIED PROBLEM	SOLUTION
Band Proportional	Slow answer	Decrease
	Great oscillation	Increase
Rate Integration	Slow answer	Increase
	Great oscillation	Decrease
Derivative Time	Slow answer or instability	Decrease
	Great oscillation	Increase

Table 4 – Guidance for manual adjustment of the PID parameters

8. MAINTENANCE

8.1 PROBLEMS WITH THE CONTROLLER

Connection errors and inadequate programming are the most common errors found during the controller operation. A final revision may avoid loss of time and damages.

The controller displays some messages to help the user identify problems:

MESSAGE	PROBLEM DESCRIPTION
----	Open input. No sensor or signal.
Err 1 Err 6	Connection and/or configuration problems. Check the wiring and the configuration.





Table 5 – Error messages

Other error messages may indicate hardware problems requiring maintenance service.

8.2 INPUT CALIBRATION









All inputs are factory calibrated and recalibration should only be done by qualified personnel. If you are not familiar with these procedures do not attempt to calibrate this instrument.

The calibration steps are:

1. Configure the input type to be calibrated in the **TYPE** parameter.
2. Configure the lower and upper limits of indication for the maximum span of the selected input type.
3. Go to the Calibration Cycle.
4. Enter the access password.
5. Enable calibration by setting **YES** in **CAL Ib** parameter.
6. Using an electrical signals simulator, apply a signal a little higher than the **low** indication limit for the selected input.
7. Access the **in.LC** parameter. With the  and  keys, adjust the display reading such as to match the applied signal. Then press the **P** key.
8. Apply a signal that corresponds to a value a little lower than the **upper** limit of indication.
9. Access the **in.HC** parameter. With the  and  keys, adjust the display reading such as to match the applied signal.
10. Return to the Operation Cycle.
11. Check the resulting accuracy. If not good enough, repeat the procedure.

Note: When checking the controller calibration with a Pt100 simulator, pay attention to the simulator minimum excitation current requirement, which may not be compatible with the 0.170 mA excitation current provided by the controller.

8.3 ANALOG OUTPUT CALIBRATION

1. Set the PV retransmission type in the OUT3 parameter.
2. Connect a milliampere meter to terminals 13 and 14 of the analog output.
3. Enter the Calibration Cycle.
4. Select parameter **RoLC**.
5. Press the  and  keys and observe the value displayed by the milliampere meter.
6. Use the  and  keys to change the controller display to the value of the current indicated on the milliampere meter.
7. Select the screen **RoHC**.
8. Press the  and  keys and observe the value shown by the milliampere meter.
9. Use the  and  keys to change the controller display to the value of the current indicated on the milliampere meter.
10. Exit the Calibration Cycle.
11. Validate the calibration performed.

9. SERIAL COMMUNICATION

The controller can be supplied with an asynchronous RS485 digital communication interface for master-slave connection to a host computer (master).

The controller works as a slave only and all commands are started by the computer which sends a request to the slave address. The addressed unit sends back the requested reply.

Broadcast commands (addressed to all indicator units in a multidrop network) are accepted but no reply is sent back in this case.

9.1 FEATURES

- Signals compatible with RS485 standard. MODBUS (RTU) Protocol. Two wire connection between 1 master and up to 31 (addressing up to 247 possible) instruments in bus topology.
- Communication signals are electrically isolated from the INPUT and POWER terminals. Not isolated from the retransmission circuit and the auxiliary voltage source when available.
- Maximum connection distance: 1000 meters.
- Time of disconnection: Maximum 2 ms after last byte.
- Programmable baud rate: 1200 to 115200 bps.
- Data Bits: 8.
- Parity: Even, Odd, or None.
- Stop bits: 1
- Time at the beginning of response transmission: maximum 100 ms after receiving the command.

The RS485 signals are:

D1	D	D +	B	Bi-directional data line.	Terminal 15
D0	$\overline{\text{D}}$	D -	A	Bi-directional inverted data line.	Terminal 16
C				Optional connection that improves the performance of the communication.	Terminal 17
GND					

Table 6 – RS485

9.2 PARAMETER CONFIGURATION

You must configure the following parameters to use the serial type:

- bAud** Communication speed.
- Prty** Communication parity.
- Addr** Communication address for the controller.

9.3 COMMUNICATION PROTOCOL

The MODBUS RTU slave is implemented. All configurable parameters can be accessed for reading or writing through the communication port. Broadcast commands are supported as well (address 0).

The available Modbus commands are:

- 03 - Read Holding Register
- 06 - Preset Single Register
- 05 - Force Single Coil

9.4 HOLDING REGISTERS TABLE

Follows a description of the usual communication registers. For full documentation download the **Registers Table for Serial Communication** in the product section of **NOVUS** website (www.novusautomation.com).

All registers are 16-bit signed integers.

ADDRESS	PARAMETER	REGISTER DESCRIPTION
0000	Active SP	Read: Active control SP (main SP, from ramp and soak or from remote SP). Write: To main SP. Range: from SPLL to SPHL .
0001	PV	Read: Process Variable. Write: Not allowed. Range: Minimum value is the one configured in SPLL and the maximum value is the one configured in SPHL . Decimal point position depends on dPPo value. In case of temperature reading, the value read is always multiplied by 10, independently of dPPo value.

ADDRESS	PARAMETER	REGISTER DESCRIPTION
0002	MV	Read: Output Power in automatic or manual mode. Write: Not allowed. See address 29. Range: 0 to 1000 (0.0 to 100.0 %).

Table 7 – Register table

10. IDENTIFICATION

N1040 -	A -	B -	C
---------	-----	-----	---

A: Outputs features:

PR: OUT1 = Pulse / OUT2 = Relay

PRRR: OUT1 = Pulse / OUT2 = OUT3 = OUT4 = Relay

PRAR: OUT1 = Pulse / OUT2 = Relay / OUT3 = 0-20 / 4-20 mA
OUT4 = Relay

B: Serial communication:

Blank: Basic version, without serial communication.

485: Version with RS485 serial, Modbus protocol.

C: Power supply:

Blank: Standard model
100~240 Vdc / 24 Vac; 50~60 Hz

24 V: 24 V Model
12~24 Vdc / 24 Vac; 50~60 Hz

11. SPECIFICATIONS

DIMENSIONS: 48 x 48 x 80 mm (1/16 DIN)
Panel cut-out: 45.5 x 45.5 mm (+0.5 -0.0 mm)
Approximate weight: 75 g

POWER SUPPLY:

Standard model: 100 to 240 Vac ($\pm 10\%$), 50/60 Hz
..... 48 to 240 Vdc ($\pm 10\%$)
24 V model: 12 to 24 Vdc / 24 Vac (-10% / $+20\%$)
Maximum consumption: 6 VA

ENVIRONMENTAL CONDITIONS:

Operation temperature: 0 to 50 °C
Relative humidity: 80 % @ 30 °C
For temperatures above 30 °C, reduce 3 % for each °C.
Internal use; Category of installation II, Pollution degree 2; Altitude < 2000 meters.

INPUT

..... Thermocouples **J, K, T**, and **Pt100** (according to **Table 1**)
Internal resolution: 32767 levels (15 bits)
Display resolution: 12000 levels (from -1999 up to 9999)
Rate of input reading: up to 10 per second (*)
Accuracy: Thermocouples J, K, T: 0.25 % of the span ± 1 °C (**)
..... Pt100: 0.2 % of the span
Input impedance: Pt100 and thermocouples: > 10 M Ω
Pt100 measurement: 3-wire type, ($\alpha=0.00385$)

With compensation for cable length, excitation current of 0.170 mA.

All input types are factory calibrated. Thermocouples according to NBR 12771/99 standard; Pt100 NBR 13773/97.

(*) Value adopted when the Digital Filter parameter is set to 0 (zero) value. For Digital Filter values other than 0, the Input Reading Rate value is 5 samples per second.

(**) The use of thermocouples requires a minimum time interval of 15 minutes for stabilization.

OUTPUTS:

OUT1: Voltage pulse, 5 V / 50 mA max.
OUT2: SPST relay; 1.5 A / 240 Vac / 30 Vdc
OUT3 (PRRR): SPST relay; 1.5 A / 240 Vac / 30 Vdc
OUT3 (PRAR): 0-20 mA or 4-20 mA
..... 500 Ohms max.; 12000 levels; Isolated
..... Accuracy: 0.25 % F.S. (***)
OUT4: SPDT relay; 3 A / 240 Vac / 30 Vdc

FRONT PANEL: IP65, Polycarbonate (PC) UL94 V-2

HOUSING: IP20, ABS+PC UL94 V-0

ELECTROMAGNETIC COMPATIBILITY: EN 61326-1:1997 and EN 61326-1/A1:1998

EMISSION: CISPR11/EN55011

IMMUNITY: EN61000-4-2, EN61000-4-3, EN61000-4-4, EN61000-4-5, EN61000-4-6, EN61000-4-8, and EN61000-4-11

SAFETY: EN61010-1:1993 and EN61010-1/A2:1995

SPECIFIC CONNECTIONS FOR TYPE FORK TERMINALS.

PROGRAMMABLE CYCLE OF PWM: From 0.5 up 100 seconds.

STARTS UP OPERATION: After 3 seconds connected to the power supply.

CERTIFICATIONS:



(***) F.S.= Full scale. Maximum range of the sensor used.

12. WARRANTY

Warranty conditions are available on our website www.novusautomation.com/warranty.