



TxIsoBlock-HRT

TEMPERATURE TRANSMITTER – USER GUIDE – V1.1x D



1. INTRODUCTION

TxIsoBlock-HRT is a configurable head mount temperature transmitter widely required in various industrial processes. Its universal input can be configured to read RTDs, thermocouples and mV signals.

It converts the input signal into a 4-20 mA linear output proportional to the configured range. **TxIsoBlock-HRT** uses the HART® communication protocol over the 4-20 mA output current loop.

The input and output are electrically isolated, enhancing their performance and user and system safety.

2. SPECIFICATIONS

Sensor input: User defined. The supported sensors are listed in **Table 1**, along with their maximum ranges.

Thermocouples: Types J, K, R, S, T, N, E, and B, according to IEC 60584 (ITS-90). Impedance >> 1 MΩ

Pt100: Excitation 0.15 mA, $\alpha = 0.00385$, according to IEC 60751 (ITS-90).

For 2-wire sensors, tie terminals 3 and 4 together.

Pt1000: Excitation 0.20 mA, $\alpha = 0.00385$, according to IEC 60751 (ITS-90).

For 2-wire sensors, tie terminals 3 and 4 together.

NTC $R_{25^{\circ}\text{C}}$: 10 kΩ ± 1 %, $B_{25/85} = 3435$.

Voltage: 0 to 50 mVdc. Impedance >> 1 MΩ.

SENSOR TYPE	MAXIMUM MEASUREMENT RANGE	MINIMUM RETRANSMISSION RANGE
Thermocouple K	-150 to 1370 °C (-238 to 2498 °F)	50 °C (90 °F)
Thermocouple J	-100 to 760 °C (-148 to 1400 °F)	50 °C (90 °F)
Thermocouple R	-50 to 1760 °C (-58 to 3200 °F)	200 °C (360 °F)
Thermocouple S	-50 to 1760 °C (-58 to 3200 °F)	200 °C (360 °F)
Thermocouple T	-160 to 400 °C (-256 to 752 °F)	50 °C (90 °F)
Thermocouple N	-270 to 1300 °C (-454 to 2372 °F)	50 °C (90 °F)
Thermocouple E	-90 to 720 °C (-130 to 1328 °F)	50 °C (90 °F)
Thermocouple B	500 to 1820 °C (932 to 3308 °F)	200 °C (360 °F)
Pt100	-200 to 650 °C (-328 to 1202 °F)	30 °C (54 °F)
Pt1000	-200 to 650 °C (-328 to 1202 °F)	30 °C (54 °F)
NTC	-30 to 120 °C (-22 to 248 °F)	10 °C (18 °F)
Voltage	0 to 50 mV	3 mV

Table 1 – Sensors accepted by the transmitter

Switch-on delay: < 10 s with damping filter set to factory setting. The accuracy is only guaranteed after 15 min.

Reference terms: Ambient: 25 °C (77 °F); voltage: 24 Vdc, load: 250 Ω. Stabilization time of 15 minutes after any setting is required.

Temperature effect:

NTC: < 0.11 % F. S. / 25 °C (45 °F)

Other sensors: < 0.05 % F. S. / 25 °C (45 °F)

(F. S. = Full Scale).

Response time: Typical 6 s with factory damping filter. This is the maximum time between a temperature step being applied in the input and the output reaching 90 % of the corresponding value.

HART protocol version: 7.

RTD cable resistance effect: 0.005 °C (0.009 °F) / Ω.

Maximum allowable cable resistance for RTD: 25 Ω.

Accuracy: Calibration error in relation to sensor measuring range (Full Scale).

Sensor Type	CURRENT LOOP		HART	
	Typical Accuracy	Minimum Accuracy	Typical Accuracy	Minimum Accuracy
Pt100 (-200 to 650 °C) (-328 to 1202 °F)	0.08 %	0.15 %	0.05 %	0.15 %
Pt1000 (-200 to 650 °C) (-328 to 1202 °F)	0.07 %	0.15 %	0.04 %	0.15 %
K, J, R, S, T, N, E, B	0.07 % (*)	0.15 % (*)	0.04 % (*)	0.15 % (*)
mV	0.07 %	0.15 %	0.04 %	0.15 %
NTC	0.20 °C (0.36 °F)	0.45 °C (0.81 °F)	0.15 °C (0.27 °F)	0.45 °C (0.81 °F)

Table 2 – Input accuracy

(*) Add Cold Junction compensation: < ± 1 °C (1.8 °F).

Power supply influence: < 0.005 % / V (percentage of the full measure range).

Output (4-20 mA): 4-20 mA current, 2-wired; linear and proportional to the configured range.

Output resolution (4-20 mA): 0.25 μA.

Power supply: 8.5 to 36 Vdc (output 4-20 mA).

Maximum load (RL): $RL(\text{max.}) = (Vdc - 8.5) / 0.0215 [\Omega]$

Where: Vdc = Power supply voltage
(8.5 to 36 Vdc)

Operating temperature: -40 to 85 °C (-40 to 185 °F).

Humidity: 0 to 90% RH.

It presents electrical isolation between input and output of 1.5 kVrms.

Internal protection against reverse polarity of the supply voltage.

Cold Junction compensation for thermocouples.

Connection wire cross section: 0.14 to 1.5 mm².

Screw tightening: 0.8 Nm.

Housing: Polyamide.

Standards and Certifications: NAMUR NE-43 standard and CE and HART® certifications.

3. CONFIGURATION

When the transmitter is used with the factory setting, no further action is required, and the transmitter is ready to be installed.

When it is necessary to change the configuration of the equipment, you should use **SigNow** software, **TxConfig II** software, or **SigNow** app.

To configure the equipment through any of the software, you must connect the **TxConfig-HRT** Configuration Interface (purchased from the manufacturer or its authorized representatives) to the USB port of the computer used and run the selected software, as shown in **Figure 1**:

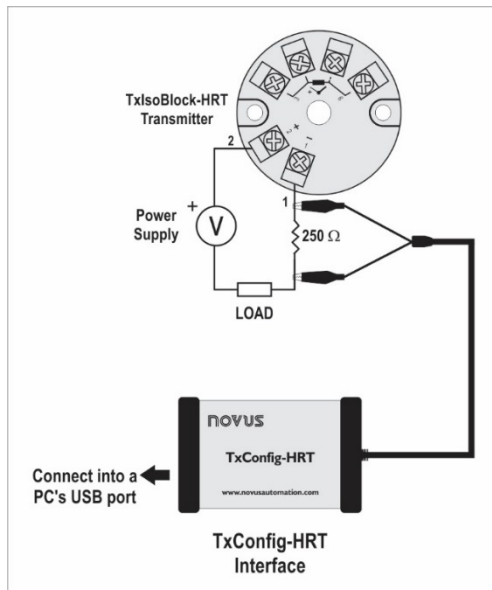

Figure 1 – TxConfig-HRT Interface connection to the TxIsoBlock-HRT

To configure the device via the **SigNow** app, you need to use an OTG cable with the **TxConfig-HRT** Configuration Interface and proceed with the recognition process (see [SMARTPHONE CONNECTIONS](#) chapter).

On **NOVUS** website, you can download the configuration software for free. To install it, simply run the file **SigNowSetup.exe** or the file **TxConfigIISetup.exe** and follow the instructions in the installer.

The **SigNow** setup application can be downloaded for free from [Google Play Store](#).

3.1 SOFTWARE AND APP

3.1.1 SIGNOW SOFTWARE

When running the **SigNow** software and connecting to the device, the following screen will appear:

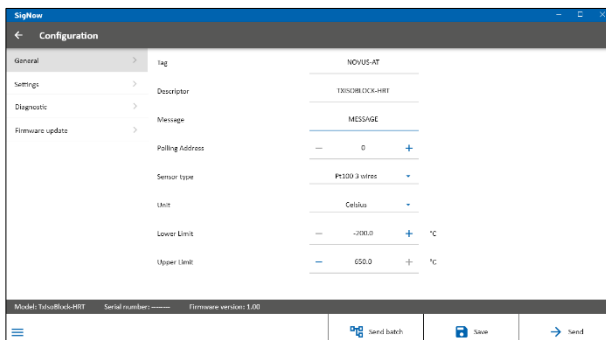

Figure 2 – SigNow configuration screen

The bottom part of the screen displays information about the model, serial number, and firmware version.

The configuration screen is divided into 4 sections: General, Settings, Diagnostic and Firmware Update.

In the General (see above) and Settings screens, you can configure the device by setting values and information for the following parameters:

- 1. Tag:** Allows you to create a short device identification (up to 8 characters).
- 2. Descriptor:** Allows you to define the descriptor to be used by the master for register (up to 16 characters).
- 3. Message:** Allows you to define a message to be used by the master for register (up to 32 characters).
- 4. Polling Address:** Allows you to define the Polling address, a dynamic (i.e., configurable) address that enables devices to be quickly identified on a network.
- 5. Sensor Type:** Allows you to select the sensor to be used. See **Table 1**.
- 6. Unit:** Allows you to select the temperature unit to be used.
- 7. Lower Limit:** Allows you to define the minimum desired temperature for the configured output type.
- 8. Upper Limit:** Allows you to define the maximum desired temperature for the configured output type.
- 9. Current Loop:** Allows you to enable the current loop. When disabled, the current remains at 4 mA.
- 10. Zero Correction:** Allows you to correct small deviations presented in the transmitter output, such as when changing a sensor.
- 11. Filter:** Damping filter.

The damping filter changes the response time of the transmitter to smooth the variations in the output. The value set in the filter indicates the time interval at which the PV will reach 63 % of its final value.

The factory setting is 1.0 s, and can be changed from 0 s to 32 s. For example, in the case where the temperature should range from 0 °C to 100 °C, if you considering the factory settings, the temperature value shall be equal to 63 °C after 1.0 s. A zero value disables this function.

- 12. Write Protection:** Allows you to enable write protection. When enabled, configuration is not allowed.
- 13. Sensor Failure:** Allows you to establish the output behavior when the transmitter indicates a failure:

Minimum: Output current goes to < 3.6 mA (down-scale), typically used for refrigeration.

Maximum: Output current goes to > 22.0 mA (up-scale), typically used for heating.

In the **SigNow** manual, available on **NOVUS** website, you can get more specific information about the buttons and the process of diagnostics and firmware update.

3.1.2 TXCONFIG II SOFTWARE

When running the **TxConfig II** software and connecting to the device, the following screen will appear:

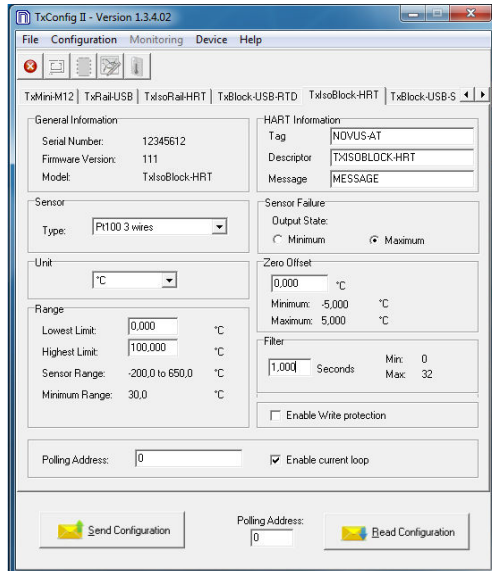

Figure 3 – TxConfig II software main screen

The fields in the screen mean:

- General Information:** This field shows information that identifies the transmitter. This information should be sent to the manufacturer in an eventual request for technical assistance.
- Sensor:** Allows you to select the sensor to be used. See Table 1.
- Unit:** Allows you to select the temperature unit to be used.
- Range:** Allows you to define de measurement range of the transmitter.
 - Lowest Limit:** Equivalent temperature for a current of 4 mA.
 - Highest Limit:** Equivalent temperature for a current of 20 mA.
 - Sensor Range:** The values chosen cannot exceed the **Range of Sensor** shown in this field. See Table 1.
 - Minimum Range:** Do not set a lower band (span) that the **Minimum Range** indicated below in this same field. See Table 1.
- HART Information:**
 - Tag:** Allows you to create a short device identification (up to 8 characters).
 - Descriptor:** Allows you to define the descriptor to be used by the master for register (up to 16 characters).
 - Message:** Allows you to define a message to be used by the master for register (up to 32 characters).
- Sensor Failure:** Allows you to establish the output behavior when the transmitter indicates a failure:
 - Minimum:** Output current goes to < 3.6 mA (down-scale), typically used for refrigeration.
 - Maximum:** Output current goes to > 22.0 mA (up-scale), typically used for heating.
- Zero Offset:** Allows you to correct small deviations presented in the transmitter output, such as when changing a sensor.
- Filter:** Damping filter.

The damping filter changes the response time of the transmitter to smooth the variations in the output. The value set in the filter indicates the time interval at which the PV will reach 63 % of its final value.

The factory setting is 1.0 s, and can be changed from 0 s to 32 s. For example, in the case where the temperature should range from 0 °C to 100 °C, if you considering the factory settings, the temperature value shall be equal to 63 °C after 1.0 s. A zero value disables this function.

- Enable Write protection:** Allows you to enable write protection. When enabled, configuration is not allowed.
- Send Configuration:** Allows you to send the new configuration. Once sent, the configuration will be immediately adopted by the transmitter.
- Read Configuration:** Allows you to read the configuration present in the connected transmitter. The screen will display the current configuration, which can be changed.
- Polling Address:** Allows you to define the Polling address, a dynamic (i.e., configurable) address that enables devices to be quickly identified on a network.
- Enable Current Loop:** Allows you to enable the current loop. When disabled, the current remains at 4 mA.

3.1.3 SIGNOW APP

When using an OTG cable and the **TxConfig-HRT Configuration Interface** to connect the equipment to your smartphone and run the **SigNow** app (see [SMARTPHONE CONNECTIONS](#) chapter), you must first enable the use of **TxConfig-HRT**.

The interface will act as an intermediary for the connection:

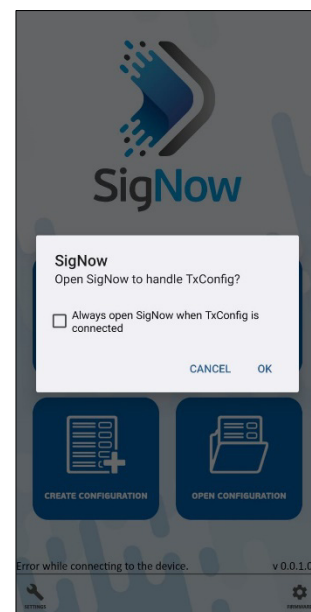

Figure 4 – Using TxConfig-HRT

After that, the app will recognize **TxConfig-HRT** and show the main screen:



Figure 5 – Main screen

To configure the equipment, just click the **Configuration** button. Then, the app will show the main screen of the TxIsoBlock-HRT Configuration section:



Figure 6 – Information screen

This screen shows information about the equipment, such as name, serial number, and firmware version.

When you open the **Config** section, you can configure the parameters displayed in the [SIGNOW SOFTWARE](#) section.

In the **SigNow** manual, available on **NOVUS** website, you can find more information about the buttons and the diagnostic process.

3.2 TERMINAL HANDHELD

To use the Handheld terminal, you must make the following connections:

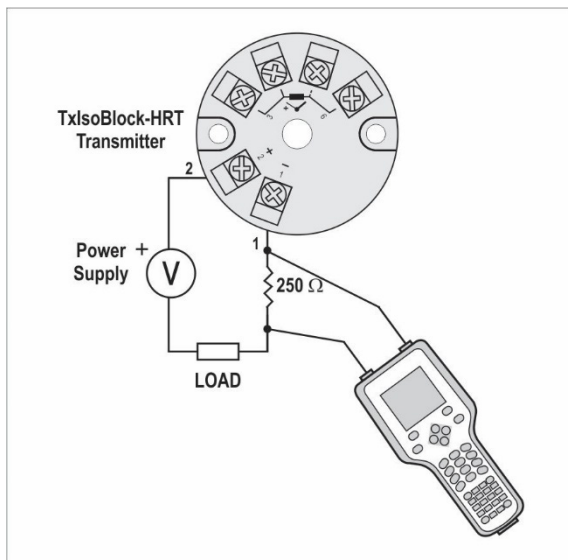

Figure 7 – Handheld terminal connection

3.3 FACTORY SETTINGS

- Sensor: Pt100 3-wire, range 0 to 100 °C.
- Maximum output for sensor failure.
- 0 °C zero correction.
- Unit: °C.
- Filter: 1.0 s.
- Address: 0.
- Current Loop: Enabled.

	<p>It is possible to configure the device via third-party software and with the help of an FSK modem to perform HART® communication.</p> <p>An EDD (Electronic Device Descriptor) file is available, which can be used with compatible systems and allows access to the settings and supervise the transmitter.</p>
	<p>To put the devices on the same network (or put them in multidrop mode), they must have different polling addresses and the current loop must be disabled.</p>

4. SMARTPHONE CONNECTIONS

Smartphones with *On the Go* (OTG) technology can be directly connected to the device via the Micro-USB input. Using the **TxConfig-HRT** Configuration Interface, it is possible to recognize and configure a TxIsoBlock-HRT by running the **SigNow** app.

To do this, as shown in **Figure 8**, you need to observe how to connect the OTG cable to the equipment:

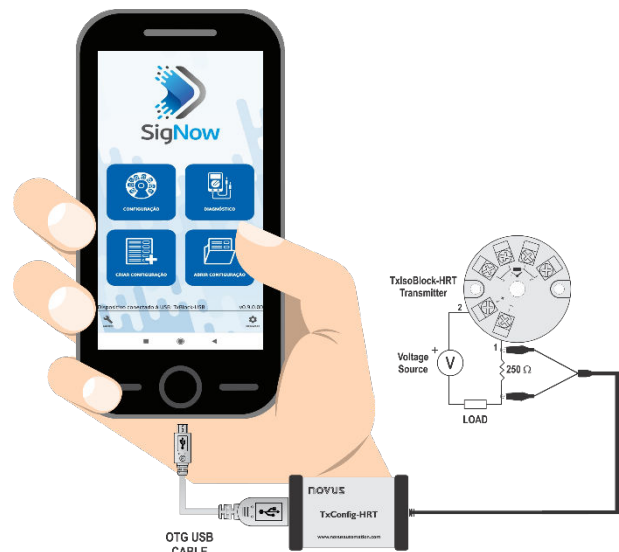

Figure 8 – OTG Cable

	<p>Incorrect positioning of the cable tip can cause the equipment not to be recognized by the app.</p>

5. MECHANICAL INSTALLATION

The TxIsoBlock-HRT transmitter is suitable to be installed in heads. Vibrations, moisture and extreme temperatures, electro-magnetic interference, high voltage, and other interferences can permanently damage the equipment and could cause error in the measured value.

The figure below shows the dimensions of the equipment:

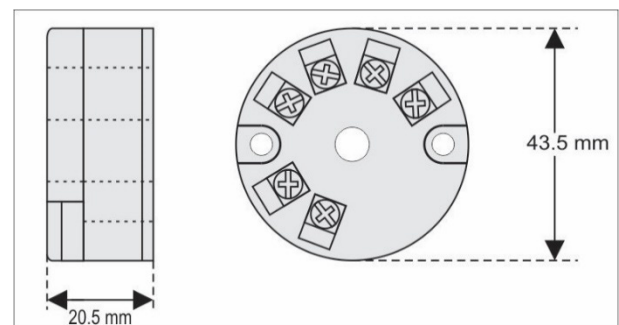

Figure 9 – Transmitter dimensions

6. ELECTRICAL INSTALLATION

- Polyamide housing to the terminals.
- Section of the cable used: 0.14 to 1.5 mm².
- Recommended torque in the terminal: 0.8 Nm.

6.1 INSTALLATION RECOMMENDATIONS

- Sensor signals conductors must go through the plant system separate from power leads (loop). If possible, in grounded conduits.
- The instruments must be powered from the instrumentation power supply circuit.
- In control and monitoring applications is essential to consider what can happen when any part of the system fails.
- RC filters (47 Ω and 100 nF) in inductor charges (contactors, solenoids, etc.) are recommended.

6.2 ELECTRICAL CONNECTIONS

The figures next show the electrical connections required. The terminals 3, 4, 5, and 6 are dedicated to the sensor connection. **LOAD** represents the 4-20 mA current measuring device (indicator, controller, data logger, etc.).

6.2.1 PT100 / PT1000 2-WIRE

When using Pt100 / Pt1000 2-wire, the terminals 3 and 4 must be interconnected, according to the figure below.

To use the Pt100 / Pt1000 2-wire, you must configure the Pt100 / Pt1000 3-wire option in **SigNow** or **TxConfig II**.

To maintain the measurement error within specifications (electrical resistance), the Pt100 / Pt1000 wire length **should be less than 30 cm**.

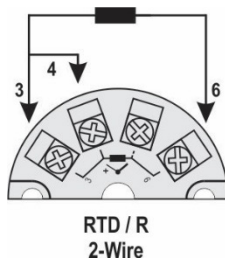

Figure 10 – Pt100 / Pt1000 2-wire connections

6.2.2 PT100 / PT1000 3-WIRE

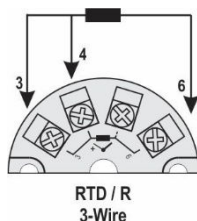

Figure 11 – Pt100 / Pt1000 3-wire connections

6.2.3 PT100 / PT1000 4-WIRE

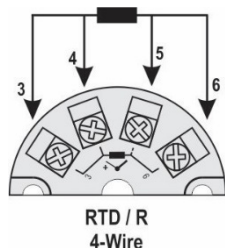

Figure 12 – Pt100 / Pt1000 4-wire connections

Pt100 / Pt1000 3 and 4-wire: For a better resistance compensation, it is recommended to use wires with same length and gauge. The transmitter compensates up to 25 Ω per wire.

6.2.4 THERMOCOUPLE

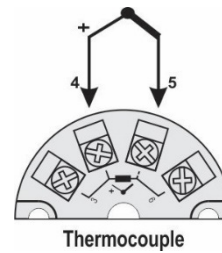

Figure 13 – Thermocouple connections

6.2.5 VOLTAGE (0-50 mV)

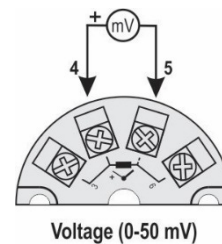

Figure 14 – 0-50 mV connections

6.2.6 NTC

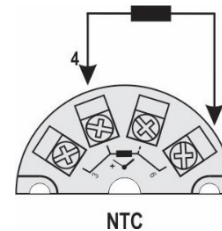

Figure 15 – NTC connections

6.2.7 OUTPUT (4-20 mA)

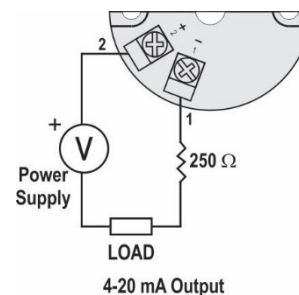

Figure 16 – 4-20 mA connections

7. OPERATION

The transmitter is factory calibrated with standardized sensors, not requiring any adjustment by the user.

Small corrections can be performed through **SigNow** or **TxConfig II** software (in units of temperature) or **SigNow** app.

You must choose the most suitable sensor and range to the process. The chosen range must not exceed the maximum range of measurement defined for the sensor and should not be smaller than the minimum range for the same sensor.

It is important to note that the transmitter accuracy is based on the maximum range of the sensor used, even when a narrower range is programmed.

Example:

- The Pt100 sensor has a maximum range of -200 to 650 $^{\circ}\text{C}$ and total accuracy of 0.08 %.

- Thus, we can have an absolute error up to 0.68 °C (0.08 % of 850 °C).
- This error is the same, no matter if total span is used (-200 to 650 °C) or a narrower user-defined span is used, like 0 to 100 °C.

8. WARRANTY

Warranty conditions are available on our website www.novusautomation.com/warranty.